

CONTROLE : FLOTTATION

IG₂/OME

Date : Lundi 08 novembre 2016

Durée : deux (2) heure (sans documents)

I. (20 points) : Expliquez dans la manière la plus exhaustive possible les huit (08) différents schémas joints ci-dessous :

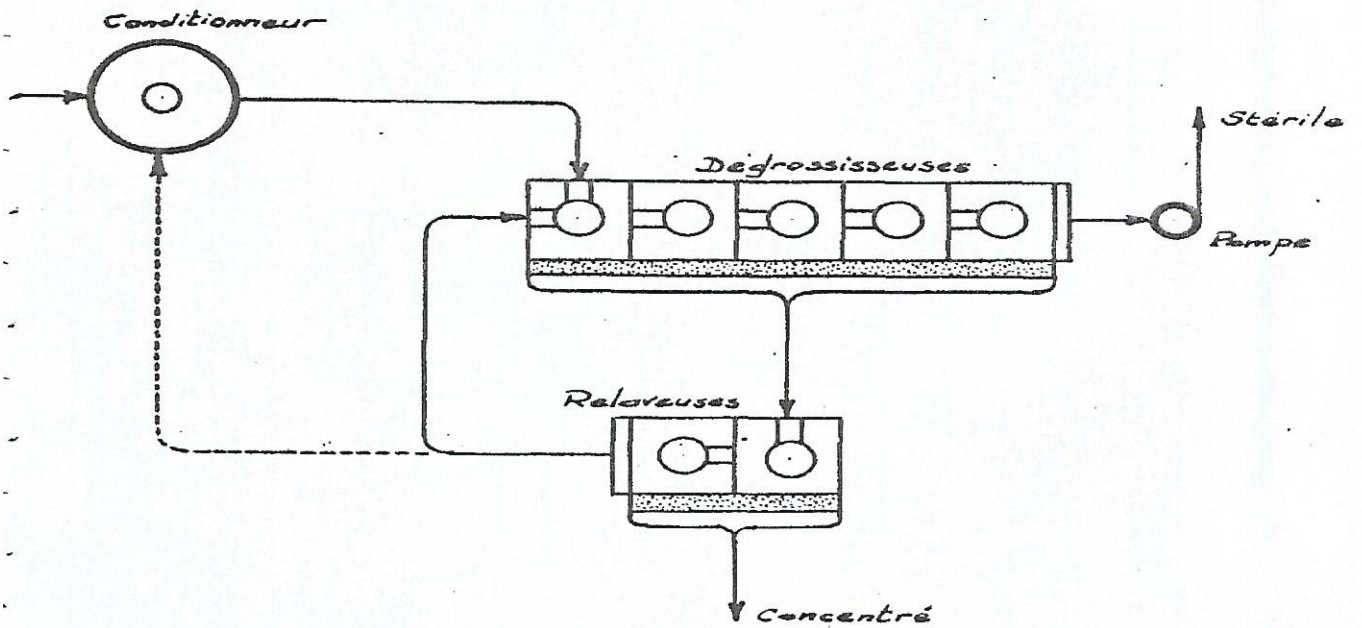
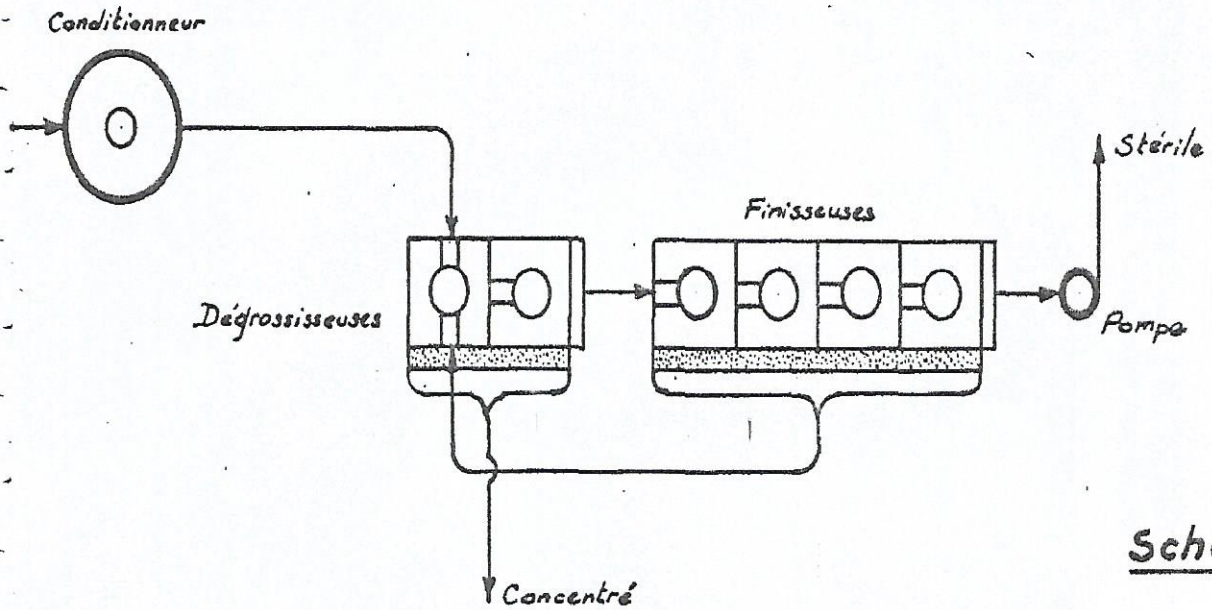

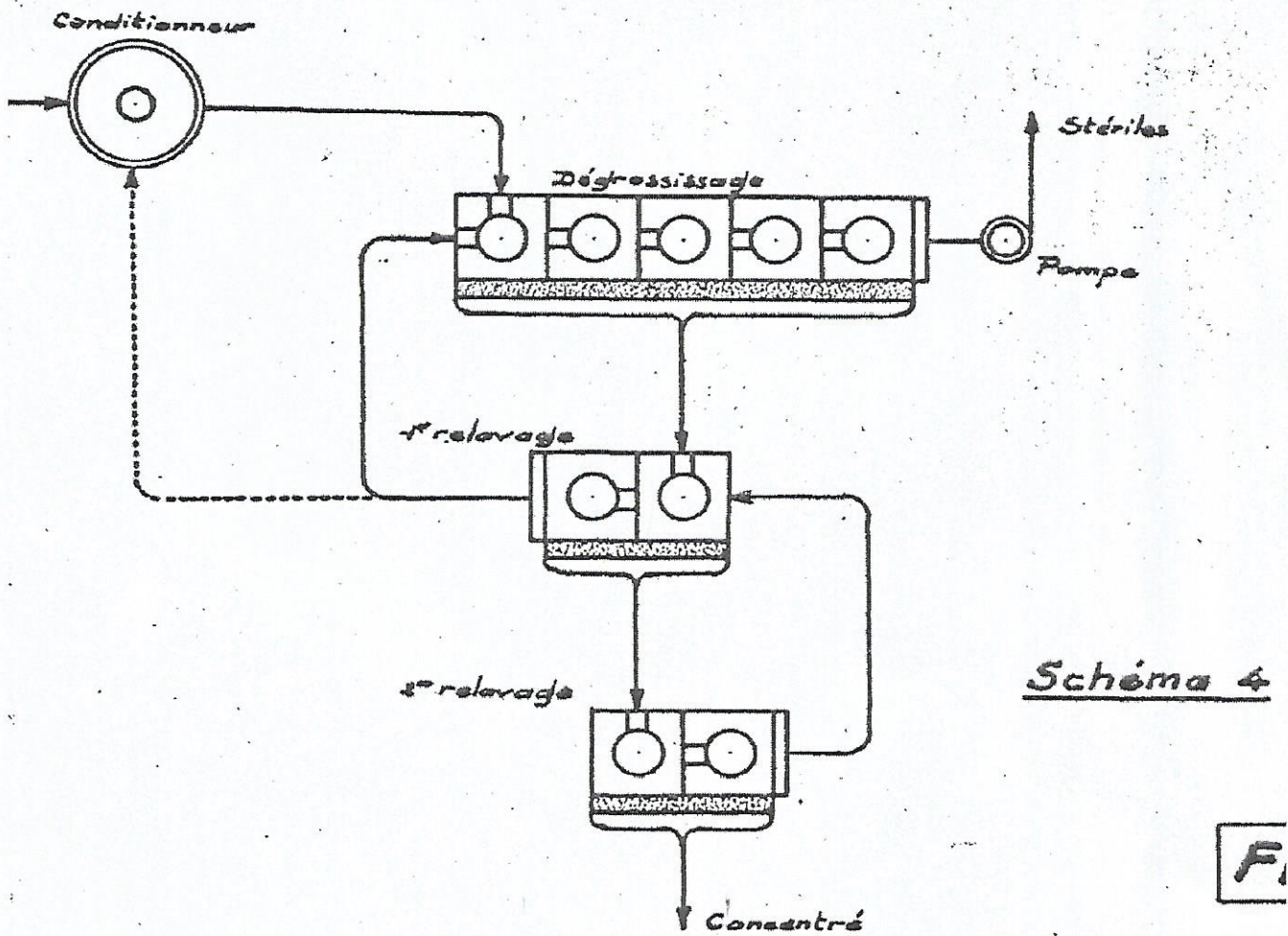
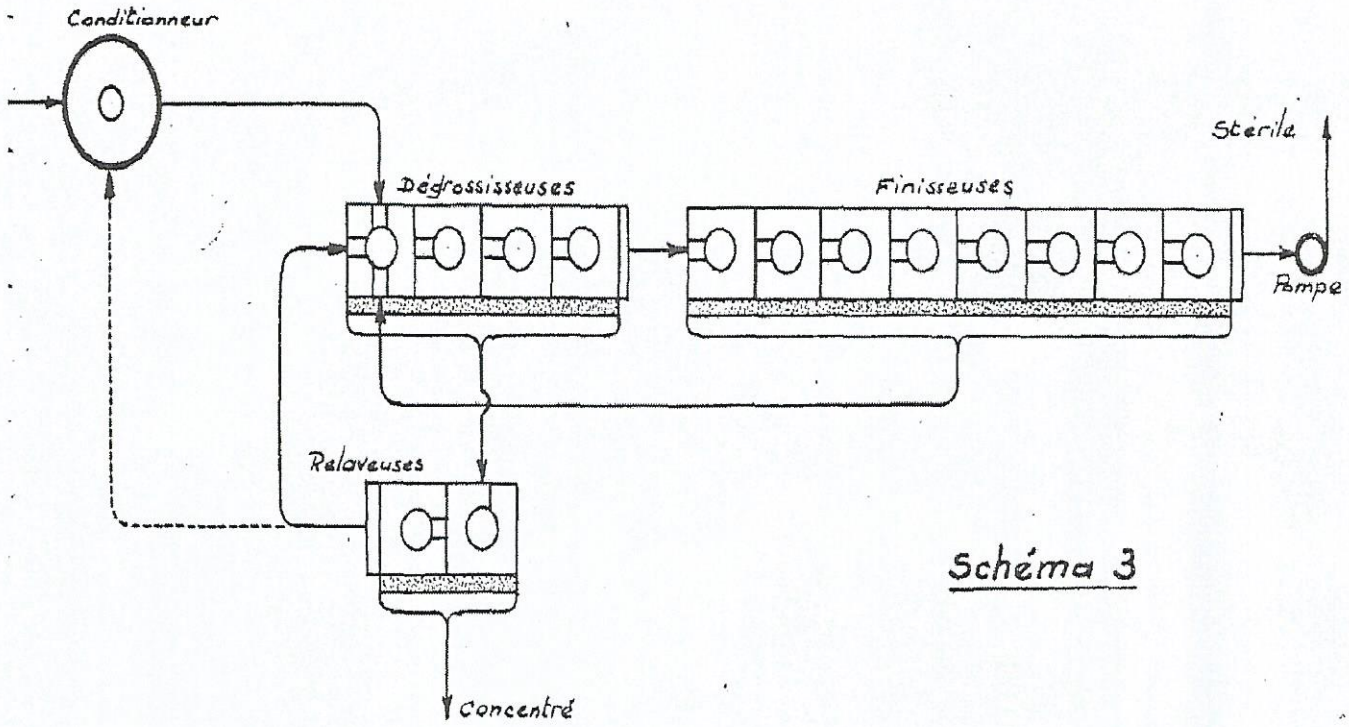

F



Schéma 6



Schéma 7

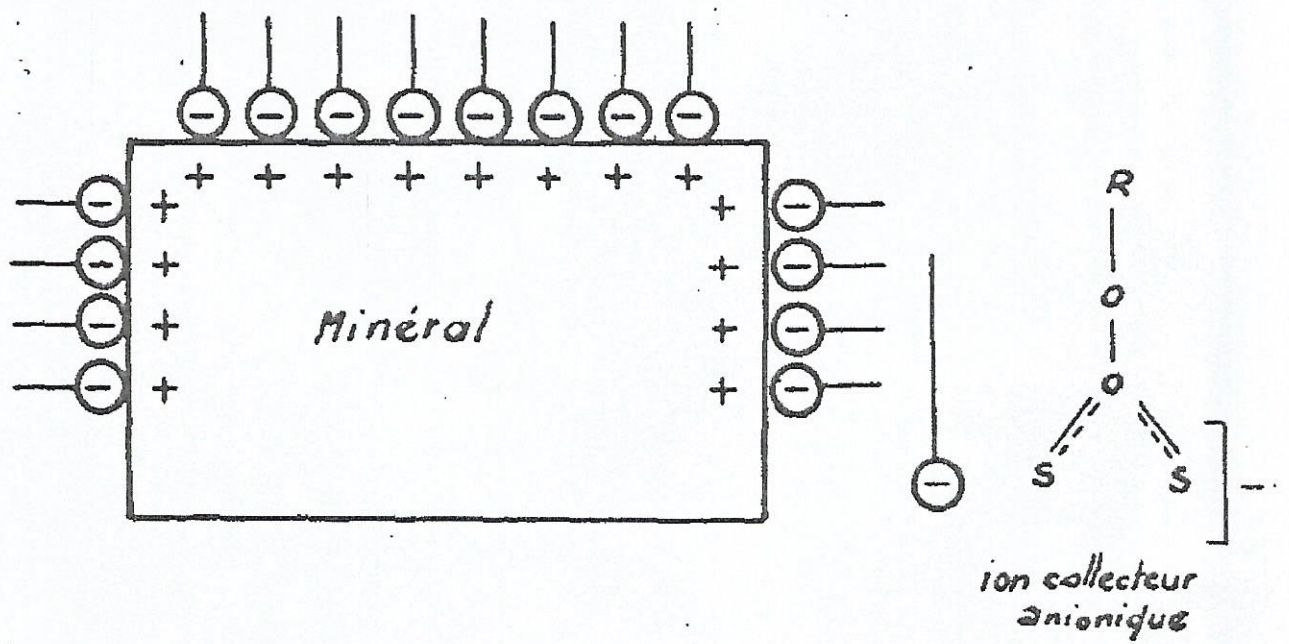
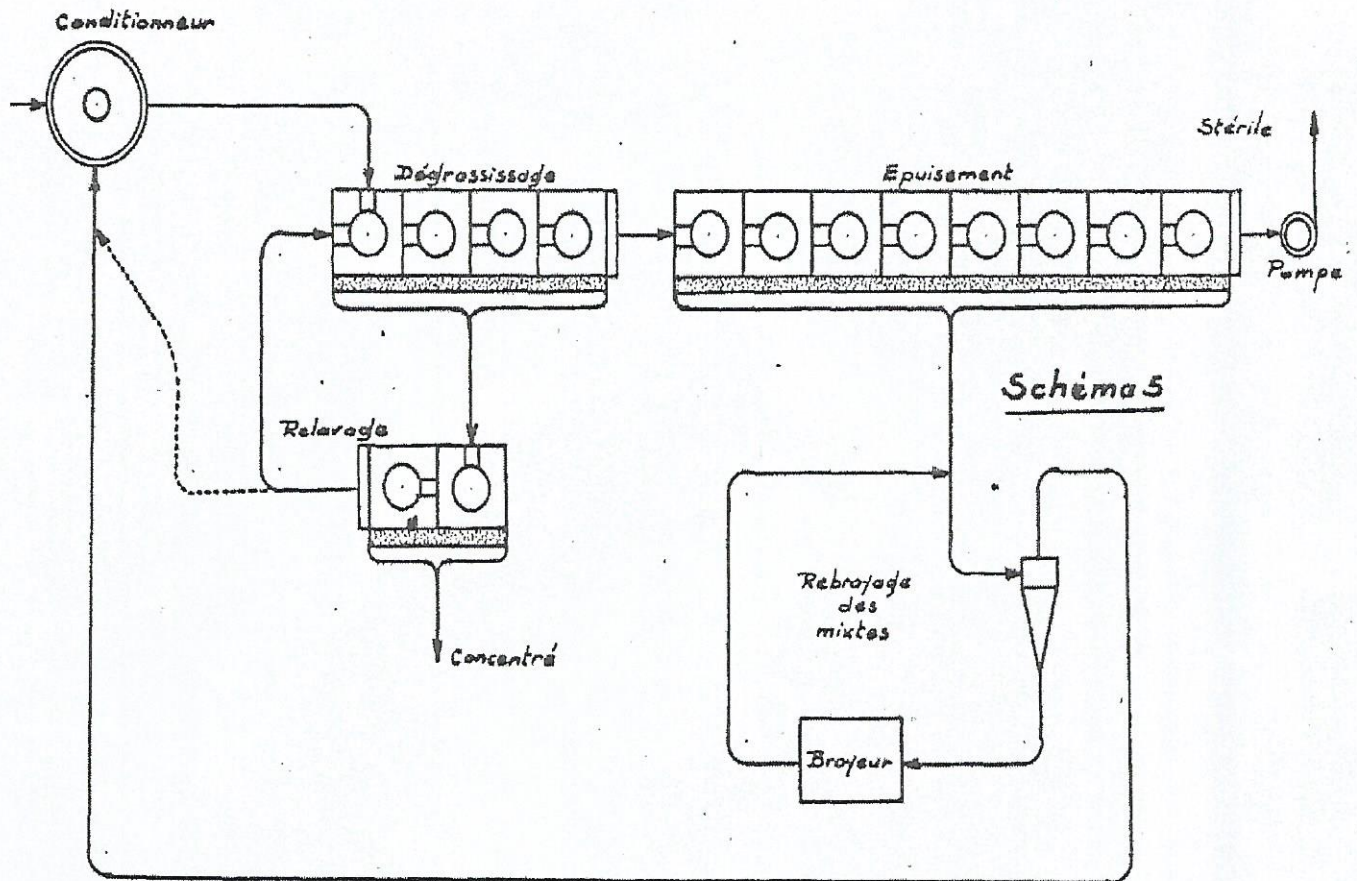
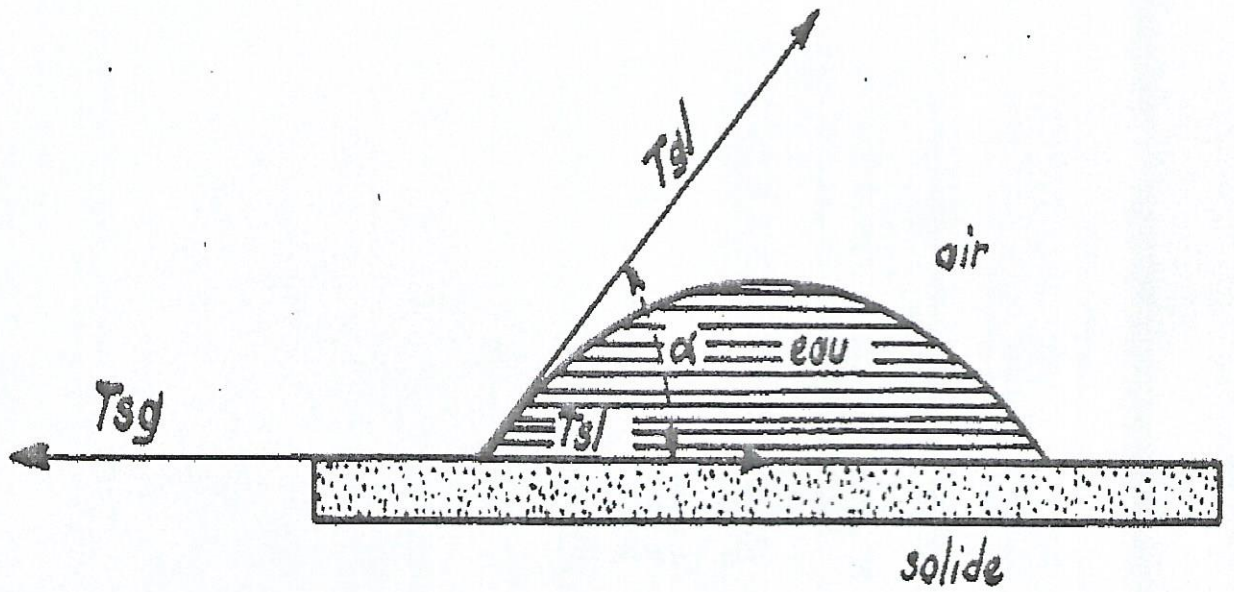
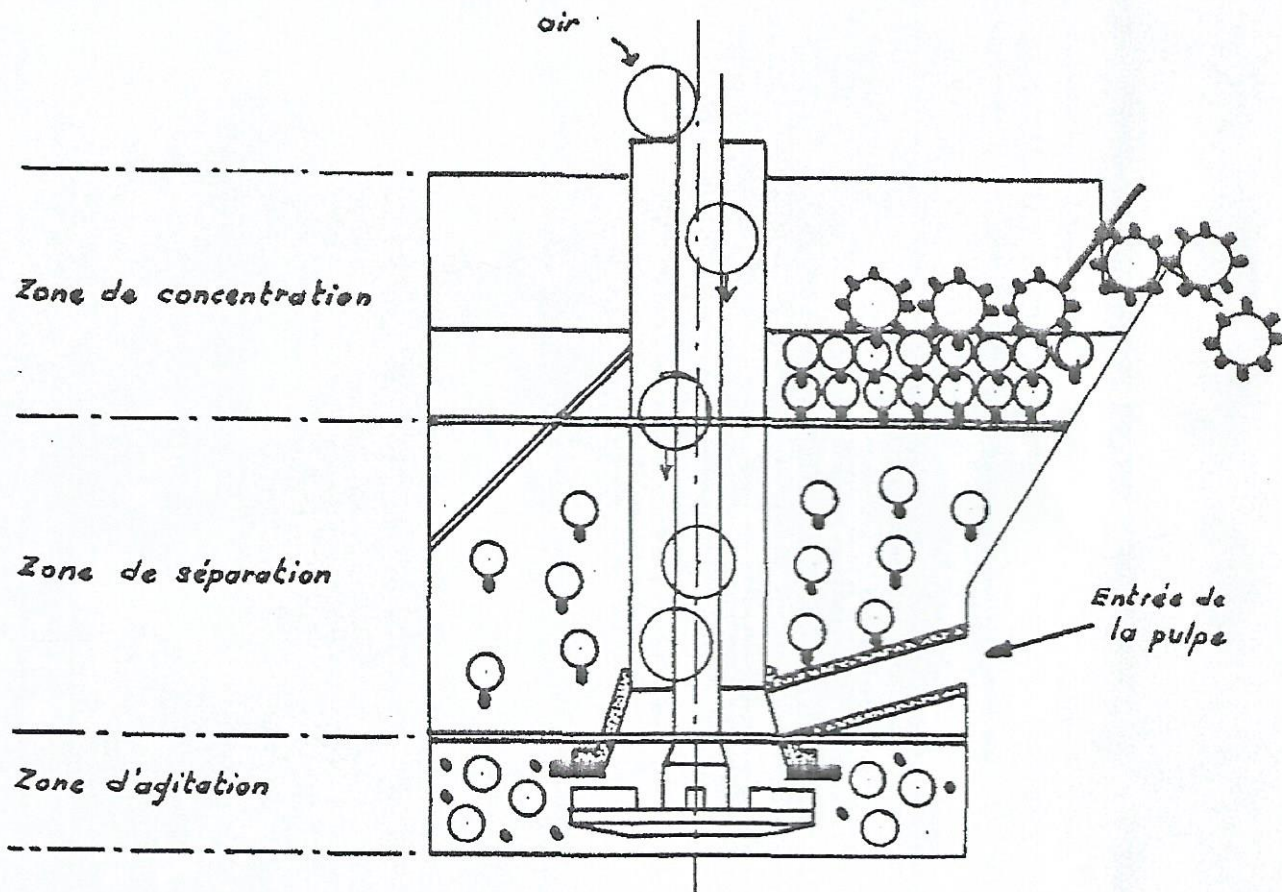

Schéma 8

Bonne chance à tous !!!!!